

Fischer & Honsel GmbH  
 Graf-Gottfried-Str. 111  
 D-59755 Arnsberg  
 +49 (0) 2932 - 989 - 0  
 www.fischer-honsel.de  
 info@fischer-honsel.de

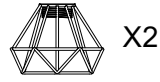

X1

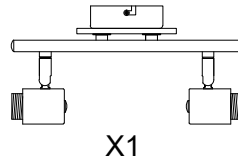
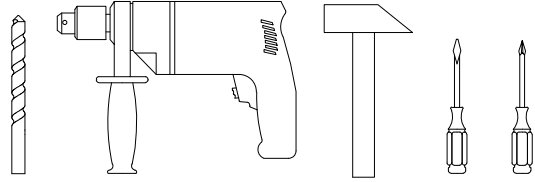

1

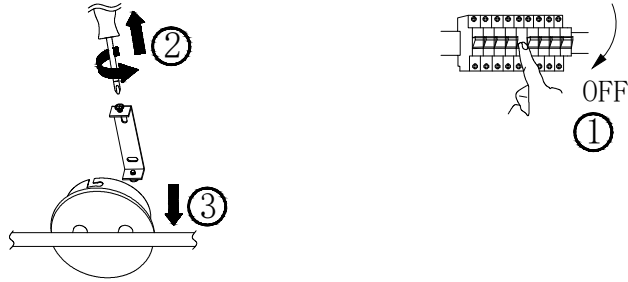

2

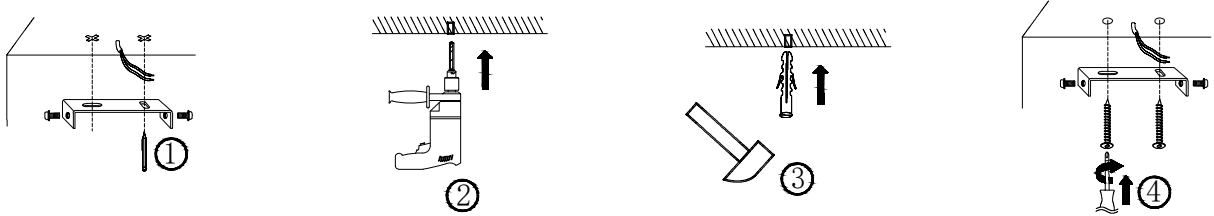

3

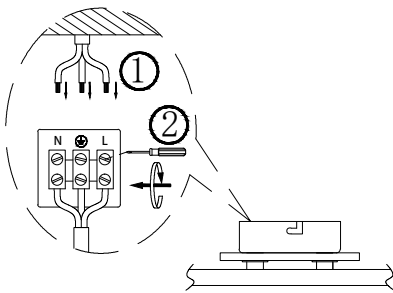

4

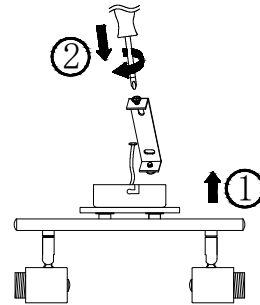

5

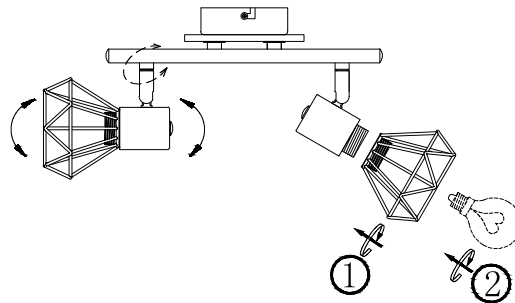

6

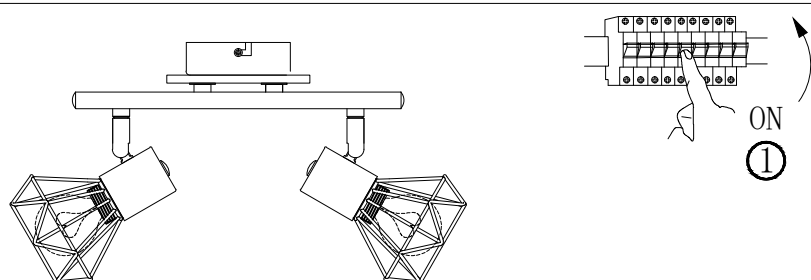

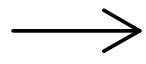
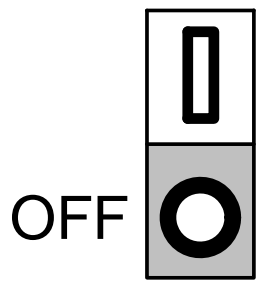
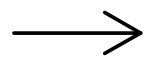
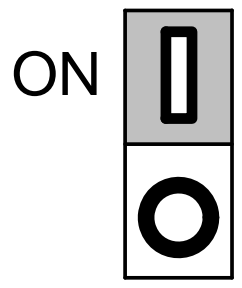
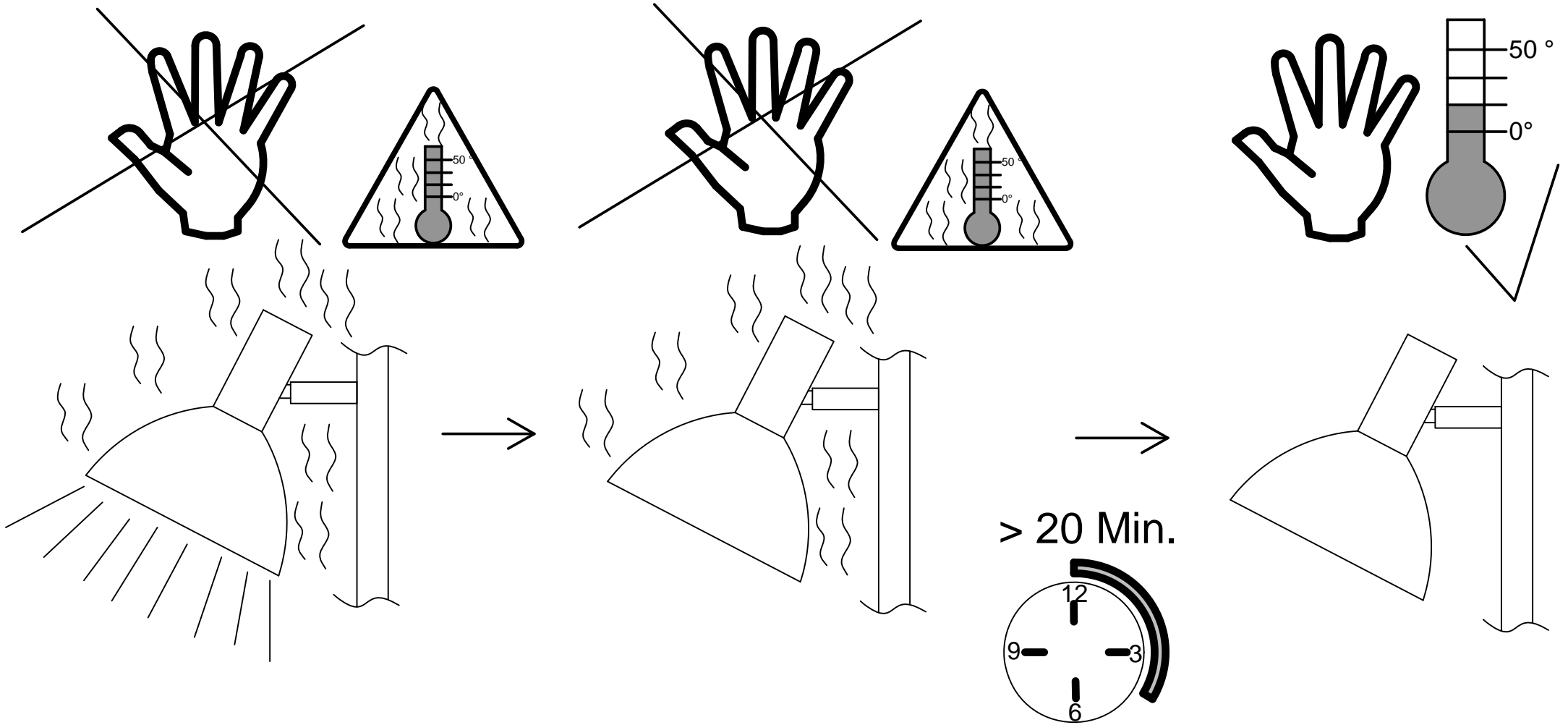

B46.73.00.00050

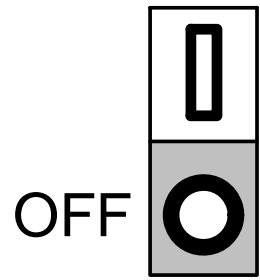

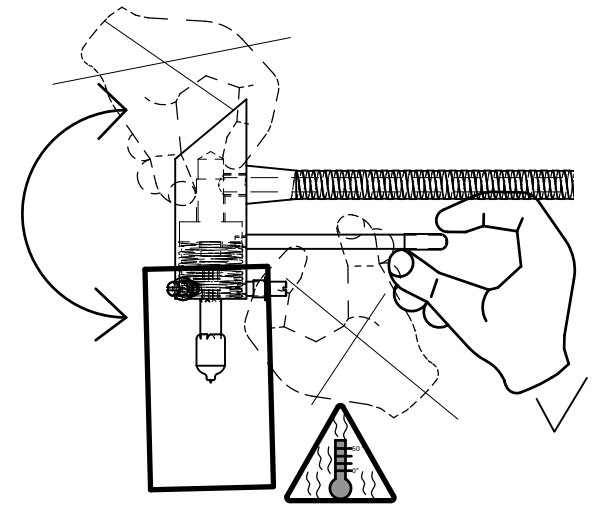
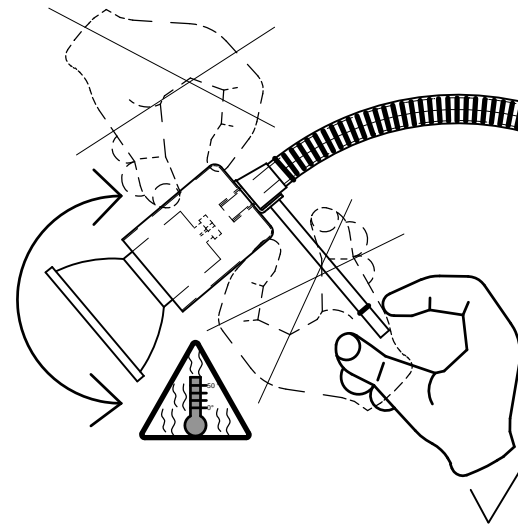
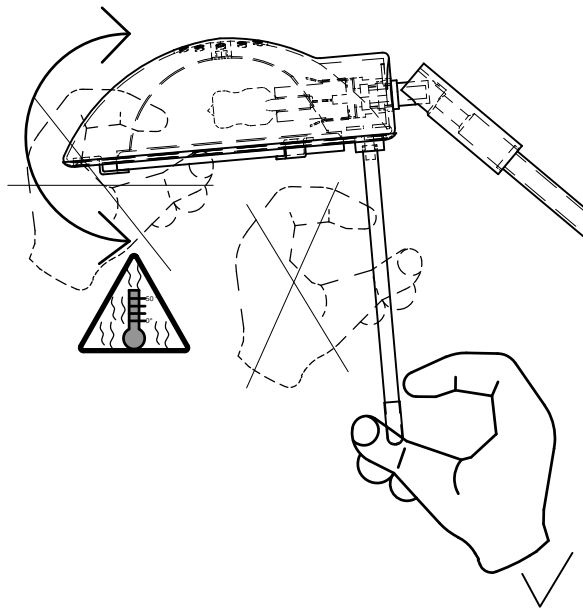
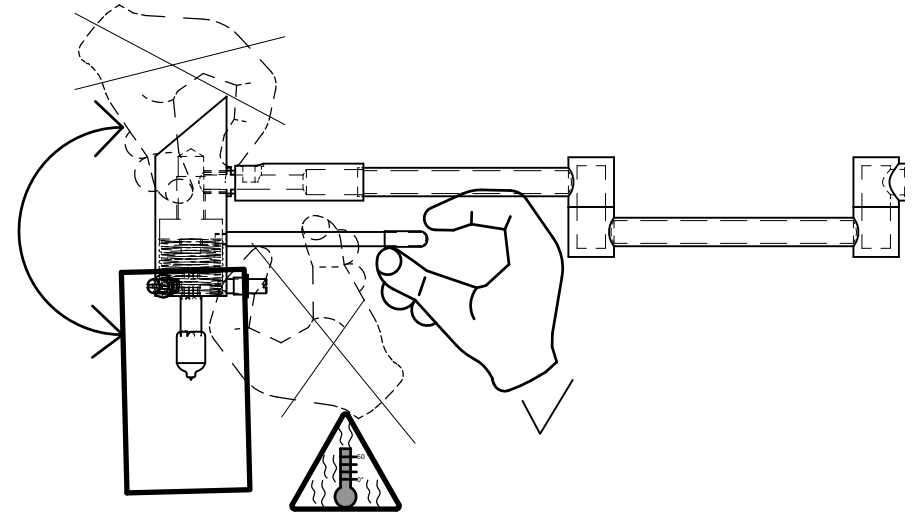
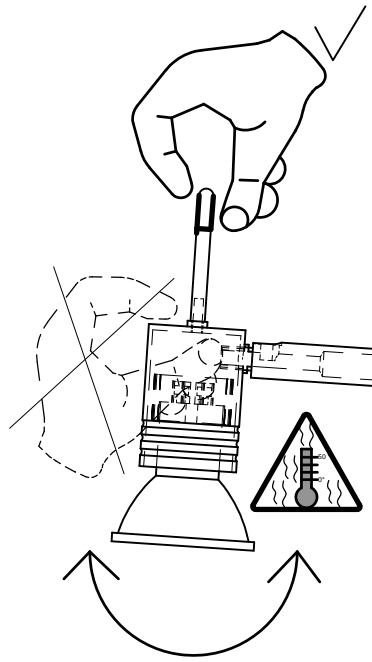
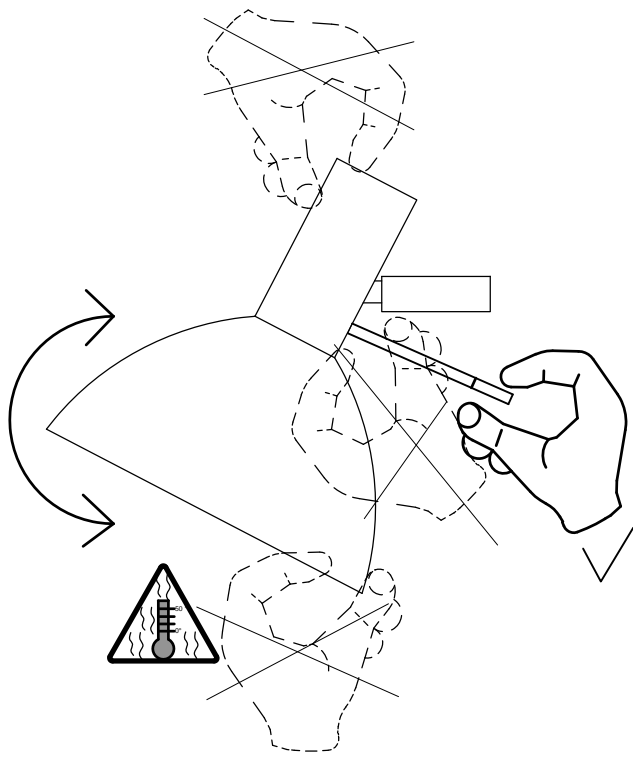



Entsorgung des Altgerätes:  
Disposal of the old device:  
Mise au rebut de l'ancien appareil :  
Smaltimento del vecchio apparecchio:  
Eliminación del dispositivo antiguo:

Das auf dem Typenschild vorhandene Symbol der durchgestrichenen Abfalltonne zeigt, dass das Produkt unter die Richtlinie 2012/19/EU fällt. Am Ende der Lebensdauer dürfen so gekennzeichnete Altgeräte nicht mit dem Hausmüll entsorgt werden, sondern sind bei einer gesonderten Entsorgungsstelle abzugeben. Die Abgabe ist für Sie kostenlos. Durch die Abgabe leisten Sie einen Beitrag zum Umwelt- und Ressourcenschutz, da enthaltenen Wertstoffe einer Wiederverwendung zugeführt werden.

The crossed-out wheeled bin symbol on the type label indicates that the product is covered by Directive 2012/19/EU. At the end of its service life, old appliances marked in this way must not be disposed of with household waste, but must be handed in at a separate disposal point. The disposal is free of charge for you. By submitting your waste, you make a contribution to the protection of the environment and resources, as the recyclable materials it contains are reused.

Le symbole de la poubelle barrée d'une croix sur la plaque signalétique indique que le produit est couvert par la directive 2012/19/UE. A la fin de leur durée de vie, les appareils usagés ainsi marqués ne doivent pas être jetés avec les ordures ménagères, mais doivent être déposés dans un point de collecte séparé. La mise à disposition est gratuite pour vous. En soumettant vos déchets, vous contribuez à la protection de l'environnement et des ressources, puisque les matières recyclables qu'ils contiennent sont réutilisées.

Il simbolo del bidone della spazzatura barrato sulla targhetta indica che il prodotto è coperto dalla direttiva 2012/19/UE. Al termine del loro ciclo di vita, i vecchi apparecchi così contrassegnati non devono essere smaltiti con i rifiuti domestici, ma devono essere consegnati in un punto di smaltimento separato. Lo smaltimento è gratuito per voi. Con l'invio dei rifiuti si contribuisce alla tutela dell'ambiente e delle risorse, poiché i materiali riciclabili in esso contenuti vengono riutilizzati.

El símbolo del contenedor con ruedas tachado en la etiqueta de tipo indica que el producto está cubierto por la Directiva 2012/19/UE. Los aparatos viejos marcados de esta manera al final de su vida útil no se deben eliminar con la basura doméstica, sino que se deben llevar a un punto de eliminación separado. La eliminación es gratuita para usted. Al enviar tus residuos, contribuyes a la protección del medio ambiente y los recursos, ya que los materiales reciclables que contienen se reutilizan.