



QUINTESSENTIALE

QN-NANTUCKET-8

220 - 240v Class I



Please install the fixture onto a sufficiently strong, load bearing surface.

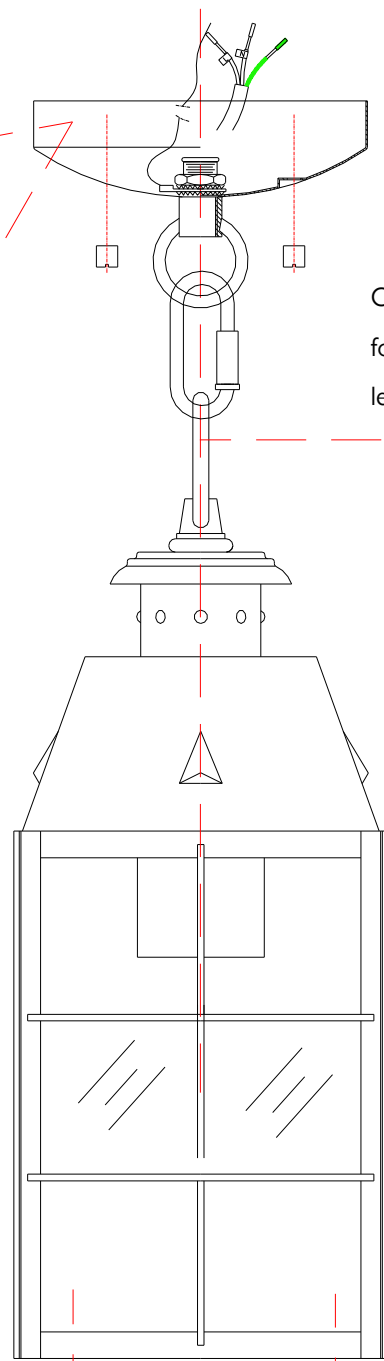
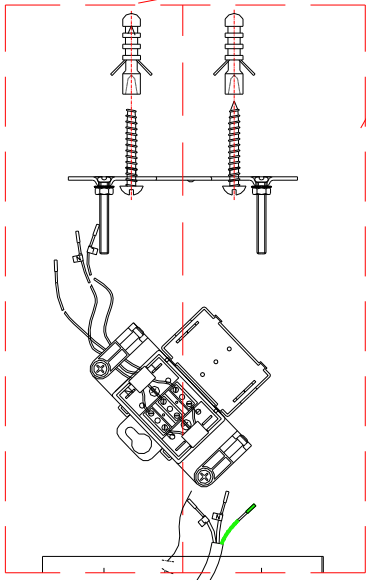

Optional chain for increased length

If this product is being installed outdoors, or a location where the product will be exposed to high levels of moisture, you should apply a silicone seal around the back-plate/canopy.

See final page for wiring instructions.

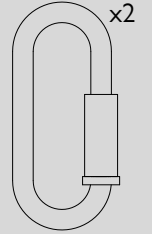
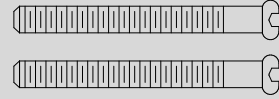
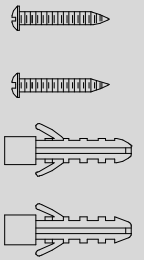
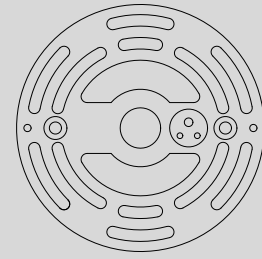
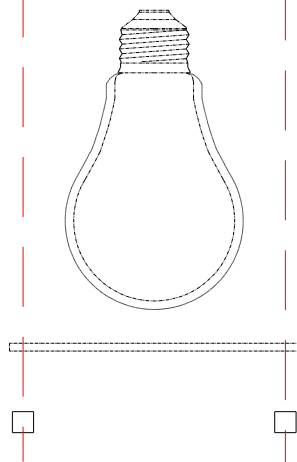

1524mm Chain

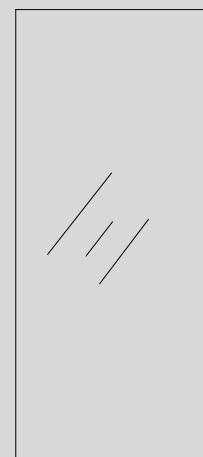
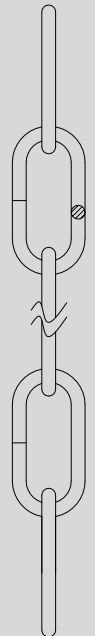
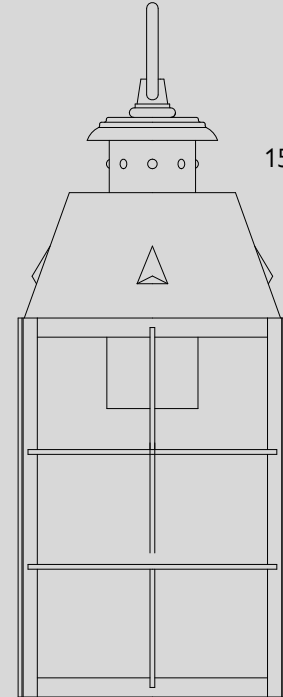

Glass: 4 pcs

Glass: 1 piece

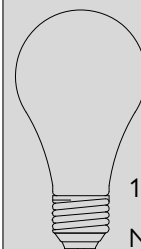
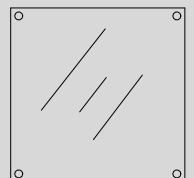

1 x MAX 60W E27
NOT SUPPLIED

Help line +44 1420 82377

IT IS RECOMMENDED THAT LIGHTS ARE INSTALLED BY A QUALIFIED ELECTRICIAN

DR-0619